

## User's Manual



## *RGB 109xi and RGB 112xi*

**Dedicated Computer-Video  
Interfaces with Audio and ADSP™**

68-410-01

**Rev. D**

10 07

# Precautions

## Safety Instructions • English



This symbol is intended to alert the user of important operating and maintenance (servicing) instructions in the literature provided with the equipment.



This symbol is intended to alert the user of the presence of uninsulated dangerous voltage within the product's enclosure that may present a risk of electric shock.

### Caution

**Read Instructions** • Read and understand all safety and operating instructions before using the equipment.

**Retain Instructions** • The safety instructions should be kept for future reference.

**Follow Warnings** • Follow all warnings and instructions marked on the equipment or in the user information.

**Avoid Attachments** • Do not use tools or attachments that are not recommended by the equipment manufacturer because they may be hazardous.

## Consignes de Sécurité • Français



Ce symbole sert à avertir l'utilisateur que la documentation fournie avec le matériel contient des instructions importantes concernant l'exploitation et la maintenance (réparation).



Ce symbole sert à avertir l'utilisateur de la présence dans le boîtier de l'appareil de tensions dangereuses non isolées posant des risques d'électrocution.

### Attention

**Lire les instructions** • Prendre connaissance de toutes les consignes de sécurité et d'exploitation avant d'utiliser le matériel.

**Conservér les instructions** • Ranger les consignes de sécurité afin de pouvoir les consulter à l'avenir.

**Respecter les avertissements** • Observer tous les avertissements et consignes marqués sur le matériel ou présentés dans la documentation utilisateur.

**Éviter les pièces de fixation** • Ne pas utiliser de pièces de fixation ni d'outils non recommandés par le fabricant du matériel car cela risquerait de poser certains dangers.

## Sicherheitsanleitungen • Deutsch



Dieses Symbol soll dem Benutzer in der im Lieferumfang enthaltenen Dokumentation besonders wichtige Hinweise zur Bedienung und Wartung (Instandhaltung) geben.



Dieses Symbol soll den Benutzer darauf aufmerksam machen, daß im Inneren des Gehäuses dieses Produktes gefährliche Spannungen, die nicht isoliert sind und die einen elektrischen Schock verursachen können, herrschen.

### Achtung

**Lesen der Anleitungen** • Bevor Sie das Gerät zum ersten Mal verwenden, sollten Sie alle Sicherheits- und Bedienungsanleitungen genau durchlesen und verstehen.

**Aufbewahren der Anleitungen** • Die Hinweise zur elektrischen Sicherheit des Produktes sollten Sie aufbewahren, damit Sie im Bedarfsfall darauf zurückgreifen können.

**Befolgen der Warnhinweise** • Befolgen Sie alle Warnhinweise und Anleitungen auf dem Gerät oder in der Benutzerdokumentation.

**Keine Zusatzgeräte** • Verwenden Sie keine Werkzeuge oder Zusatzgeräte, die nicht ausdrücklich vom Hersteller empfohlen wurden, da diese eine Gefahrenquelle darstellen können.

## Instrucciones de seguridad • Español



Este símbolo se utiliza para advertir al usuario sobre instrucciones importantes de operación y mantenimiento (o cambio de partes) que se desean destacar en el contenido de la documentación suministrada con los equipos.



Este símbolo se utiliza para advertir al usuario sobre la presencia de elementos con voltaje peligroso sin protección aislante, que puedan encontrarse dentro de la caja o alojamiento del producto, y que puedan representar riesgo de electrocución.

### Precaución

**Leer las instrucciones** • Leer y analizar todas las instrucciones de operación y seguridad, antes de usar el equipo.

**Conservar las instrucciones** • Conservar las instrucciones de seguridad para futura consulta.

**Obedecer las advertencias** • Todas las advertencias e instrucciones marcadas en el equipo o en la documentación del usuario, deben ser obedecidas.

**Evitar el uso de accesorios** • No usar herramientas o accesorios que no sean específicamente recomendados por el fabricante, ya que podrían implicar riesgos.

### Warning

**Power sources** • This equipment should be operated only from the power source indicated on the product. This equipment is intended to be used with a main power system with a grounded (neutral) conductor. The third (grounding) pin is a safety feature, do not attempt to bypass or disable it.

**Power disconnection** • To remove power from the equipment safely, remove all power cords from the rear of the equipment, or the desktop power module (if detachable), or from the power source receptacle (wall plug).

**Power cord protection** • Power cords should be routed so that they are not likely to be stepped on or pinched by items placed upon or against them.

**Servicing** • Refer all servicing to qualified service personnel. There are no user-serviceable parts inside. To prevent the risk of shock, do not attempt to service this equipment yourself because opening or removing covers may expose you to dangerous voltage or other hazards.

**Slots and openings** • If the equipment has slots or holes in the enclosure, these are provided to prevent overheating of sensitive components inside. These openings must never be blocked by other objects.

**Lithium battery** • There is a danger of explosion if battery is incorrectly replaced. Replace it only with the same or equivalent type recommended by the manufacturer. Dispose of used batteries according to the manufacturer's instructions.

### Avertissement

**Alimentations** • Ne faire fonctionner ce matériel qu'avec la source d'alimentation indiquée sur l'appareil. Ce matériel doit être utilisé avec une alimentation principale comportant un fil de terre (neutre). Le troisième contact (de mise à la terre) constitue un dispositif de sécurité : n'essayez pas de le contourner ni de le désactiver.

**Déconnexion de l'alimentation** • Pour mettre le matériel hors tension sans danger, déconnectez tous les cordons d'alimentation de l'arrière de l'appareil ou du module d'alimentation de bureau (s'il est amovible) ou encore de la prise secteur.

**Protection du cordon d'alimentation** • Acheminer les cordons d'alimentation de manière à ce que personne ne risque de marcher dessus et à ce qu'ils ne soient pas écrasés ou pincés par des objets.

**Réparation-maintenance** • Faire exécuter toutes les interventions de réparation-maintenance par un technicien qualifié. Aucun des éléments internes ne peut être réparé par l'utilisateur. Afin d'éviter tout danger d'électrocution, l'utilisateur ne doit pas essayer de procéder lui-même à ces opérations car l'ouverture ou le retrait des couvercles risquent de l'exposer à de hautes tensions et autres dangers.

**Fentes et orifices** • Si le boîtier de l'appareil comporte des fentes ou des orifices, ceux-ci servent à empêcher les composants internes sensibles de surchauffer. Ces ouvertures ne doivent jamais être bloquées par des objets.

**Lithium Batterie** • Il a danger d'explosion s'il y a un remplacement incorrect de la batterie. Remplacer uniquement avec une batterie du même type ou d'un type équivalent recommandée par le constructeur. Mettre au reut les batteries usagées conformément aux instructions du fabricant.

### Vorsicht

**Stromquellen** • Dieses Gerät sollte nur über die auf dem Produkt angegebene Stromquelle betrieben werden. Dieses Gerät wurde für eine Verwendung mit einer Hauptstromleitung mit einem geerdeten (neutralen) Leiter konzipiert. Der dritte Kontakt ist für einen Erdschluß, und stellt eine Sicherheitsfunktion dar. Diese sollte nicht umgangen oder außer Betrieb gesetzt werden.

**Stromunterbrechung** • Um das Gerät auf sichere Weise vom Netz zu trennen, sollten Sie alle Netzkabel aus der Rückseite des Gerätes, aus der externen Stromversorgung (falls dies möglich ist) oder aus der Wandsteckdose ziehen.

**Schutz des Netzkabels** • Netzkabel sollten stets so verlegt werden, daß sie nicht im Weg liegen und niemand darauf treten kann oder Objekte darauf- oder unmittelbar dagegen gestellt werden können.

**Wartung** • Alle Wartungsmaßnahmen sollten nur von qualifiziertem Servicepersonal durchgeführt werden. Die internen Komponenten des Gerätes sind wartungsfrei. Zur Vermeidung eines elektrischen Schocks versuchen Sie in keinem Fall, dieses Gerät selbst öffnen, da beim Entfernen der Abdeckungen die Gefahr eines elektrischen Schlags und/oder andere Gefahren bestehen.

**Schlitze und Öffnungen** • Wenn das Gerät Schlitze oder Löcher im Gehäuse aufweist, dienen diese zur Vermeidung einer Überhitzung der empfindlichen Teile im Inneren. Diese Öffnungen dürfen niemals von anderen Objekten blockiert werden.

**Lithium-Batterie** • Explosionsgefahr, falls die Batterie nicht richtig ersetzt wird. Ersetzen Sie verbrauchte Batterien nur durch den gleichen oder einen vergleichbaren Batterietyp, der auch vom Hersteller empfohlen wird. Entsorgen Sie verbrauchte Batterien bitte gemäß den Herstelleranweisungen.

### Advertencia

**Alimentación eléctrica** • Este equipo debe conectarse únicamente a la fuente/tipo de alimentación eléctrica indicada en el mismo. La alimentación eléctrica de este equipo debe provenir de un sistema de distribución general con conductor neutro a tierra. La tercera pata (puesta a tierra) es una medida de seguridad, no puentearla ni eliminarla.

**Desconexión de alimentación eléctrica** • Para desconectar con seguridad la acometida de alimentación eléctrica al equipo, desenchufar todos los cables de alimentación en el panel trasero del equipo, o desenchufar el módulo de alimentación (si fuera independiente), o desenchufar el cable del receptáculo de la pared.

**Protección del cables de alimentación** • Los cables de alimentación eléctrica se deben instalar en lugares donde no sean pisados ni apretados por objetos que se puedan apoyar sobre ellos.

**Reparaciones/mantenimiento** • Solicitar siempre los servicios técnicos de personal calificado. En el interior no hay partes a las que el usuario deba acceder. Para evitar riesgo de electrocución, no intentar personalmente la reparación/mantenimiento de este equipo, ya que al abrir o extraer las tapas puede quedar expuesto a voltajes peligrosos u otros riesgos.

**Ranuras y aberturas** • Si el equipo posee ranuras o orificios en su caja/alojamiento, es para evitar el sobrecalentamiento de componentes internos sensibles. Estas aberturas nunca se deben obstruir con otros objetos.

**Batería de litio** • Existe riesgo de explosión si esta batería se coloca en la posición incorrecta. Cambiar esta batería únicamente con el mismo tipo (o su equivalente) recomendado por el fabricante. Desachar las baterías usadas siguiendo las instrucciones del fabricante.

# Precautions

## 安全须知 • 中文



这个符号提示用户该设备用户手册中有重要的操作和维护说明。



这个符号警告用户该设备机壳内有露的危险电压,有触电危险。

### 注意

**阅读说明书** • 用户使用该设备前必须阅读并理解所有安全和使用说明。

**保存说明书** • 用户应保存安全说明书以备将来使用。

**遵守警告** • 用户应遵守产品和用户指南上的所有安全和操作说明。

**避免追加** • 不要使用该产品厂商没有推荐的工具或追加设备,以避免危险。

## FCC Class A Notice

This equipment has been tested and found to comply with the limits for a Class A digital device, pursuant to part 15 of the FCC Rules. Operation is subject to the following two conditions: (1) this device may not cause harmful interference, and (2) this device must accept any interference received, including interference that may cause undesired operation. The Class A limits are designed to provide reasonable protection against harmful interference when the equipment is operated in a commercial environment. This equipment generates, uses, and can radiate radio frequency energy and, if not installed and used in accordance with the instruction manual, may cause harmful interference to radio communications. Operation of this equipment in a residential area is likely to cause harmful interference, in which case the user will be required to correct the interference at his own expense.

### NOTE

*This unit was tested with shielded cables on the peripheral devices. Shielded cables must be used with the unit to ensure compliance with FCC emissions limits.*

For more information on safety guidelines, regulatory compliances, EMI/EMF compatibility, accessibility, and related topics, see the **["Extron Safety and Regulatory Compliance Guide"](#)** on the Extron website.

### 警告

**电源** • 该设备只能使用产品上标明的电源。设备必须使用有地线的供电系统供电。第三条线(地线)是安全设施,不能不用或跳过。

**拔掉电源** • 为安全地从设备拔掉电源,请拔掉所有设备后或桌面电源的电源线,或任何接到市电系统的电源线。

**电源线保护** • 妥善布线, 避免被踩踏,或重物挤压。

**维护** • 所有维修必须由认证的维修人员进行。设备内部没有用户可以更换的零件。为避免出现触电危险不要自己试图打开设备盖子维修该设备。

**通风孔** • 有些设备机壳上有通风槽或孔,它们是用来防止机内敏感元件过热。不要用任何东西挡住通风孔。

**锂电池** • 不正确的更换电池会有爆炸的危险。必须使用与厂家推荐的相同或相近型号 的电池。按照生产厂的建议处理废弃电池。

# Table of Contents

---

<b>Chapter 1 • Introduction</b> .....	1-1
About this Manual .....	1-2
About the Interfaces .....	1-2
Features .....	1-3
<b>Chapter 2 • Controls and Installation</b> .....	2-1
<b>Front and Rear Panels</b> .....	2-2
Front panel features .....	2-2
Rear panel features .....	2-3
<b>Installation</b> .....	2-5
Overview .....	2-5
Setting internal jumpers .....	2-6
Mounting the interface .....	2-9
Cabling .....	2-11
Connecting audio .....	2-12
Unbalanced audio .....	2-12
Balanced audio .....	2-13
<b>Appendix A • Reference Information</b> .....	A-1
<b>Specifications</b> .....	A-2
<b>Part Numbers</b> .....	A-4
Included parts .....	A-4
Optional accessories .....	A-4
BNC cables .....	A-5
Mounting Templates .....	A-6

*All trademarks mentioned in this manual are the properties of their respective owners.*



# 1 Chapter One

## **Introduction**

About this Manual

About the Interfaces

Features

## About this Manual

This manual documents two dedicated RGB interface units: the RGB 109xi, and the RGB 112xi. Unless otherwise specified, references to “the interface” in this manual pertain to the features or operation of both interfaces.

## About the Interfaces

Both dedicated interfaces have the same features, but each works with a specific type of computer.

The RGB 109xi is a high-resolution, dedicated VGA/XGA/SVGA/SXGA computer-video interface. It uses a 15-pin HD connector.

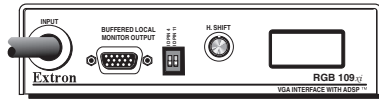

**Figure 1-1 — RGB 109xi interface**

The RGB 112xi is a high-resolution, universal workstation interface that is compatible with all workstations that use a 13W3 video connector, such as Sun, IBM PowerPC, SGI, and NeXT workstations.

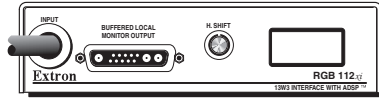

**Figure 1-2 — RGB 112xi interface**

**NOTE** For each RGB 112xi, Extron provides a multi-frequency termination adapter (MFTA) to be used if there is no local monitor. The adapter is attached by a chain to the interface, and an instruction card is attached to the adapter.

## Features

Each interface includes the features listed below. See “Front and Rear Panels” on page 2-2 for information about the controls.

**ADSP™ (Advanced Digital Sync Processing™)** — Allows sync processing operations, such as horizontal centering, to occur without affecting the signal’s sync timing. This allows horizontal centering to be applied to signals that are output to digital display devices, such as LCD (liquid crystal display) projectors, DLP (digital light processing) projectors, and plasma displays.

**Auto power** — Turns on power to the interface automatically when a video signal is received from the computer. You can determine that the interface is on if the scan rate indicator LCD displays a scan rate.

**Buffered local monitor output** — Allows you to view the displayed image on a local monitor located up to 150 feet from the interface without signal reflections or crosstalk.

**Horizontal shift** — Allows you to adjust the horizontal placement of the image on the screen. Also called “horizontal centering”.

**Gain/Peak control** — Increases video signal voltages to compensate for signal degradation caused by long cable lengths.

**Scan rate indicator LCD** — Displays the horizontal and vertical sync frequencies of the computer, and the minimum and maximum points of adjustments to horizontal shift.



# Chapter Two

## **Controls and Installation**

Front and Rear Panels

Installation

## Front and Rear Panels

### Front panel features

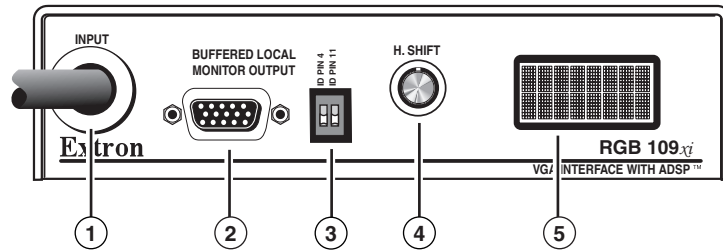

**Figure 2-1 — Front panel features**

- 1 **Video Input cable** — Attaches the interface to the computer or workstation. The type of connector depends on the interface model:

RGB 109xi: 15-pin HD male  
 RGB 112xi: 13W3 male

- 2 **Buffered Local Monitor Output Connector** — Attaches to the local monitor's video signal cable. The type of connector depends on the interface model:

RGB 109xi: 15-pin HD female  
 RGB 112xi: 13W3 female

**NOTE** *If you are not using a local monitor with the RGB 112xi, you must attach an MFTA (multi-frequency termination adapter) to simulate a monitor.*

- 3 **ID Pin switches (RGB 109xi only)** — Allows the user to set the correct ID bit termination:

#### ID PIN 4 & ID PIN 11

**ID PIN 4**  
**ID PIN 11**  
 On — Set both pins to On (up) if you are using the RGB 109xi interface with a laptop computer that is not attached to a local monitor.

**Off** — Set both pins to Off (down) if you are attaching a local monitor to the interface.

- 4 **Horizontal Shift control** — Controls the screen image horizontal centering. To adjust the horizontal shift, turn the knob in either direction and observe the left/right movement of the image on the screen. Stop when the image is centered.

**NOTE** *If the DDSP™ DIP switch on the rear panel (3) is set to On, the horizontal shift control is disabled.*

While the horizontal shift control is active, "H-SHIFT" appears in the scan rate indicator LCD (5) and for a further three seconds after the control is no longer active. When the control reaches its maximum or minimum point, "MAX" or "MIN" appears in the scan rate indicator LCD.

- 5 **Scan rate indicator LCD** — Shows the scan rate for the selected input, in kilohertz (kHz), on the top line. The vertical scan frequency, in Hz, appears on the bottom line. In addition, if the horizontal shift control is activated, or the minimum or maximum limits are reached, the LCD displays the status.

### Rear panel features

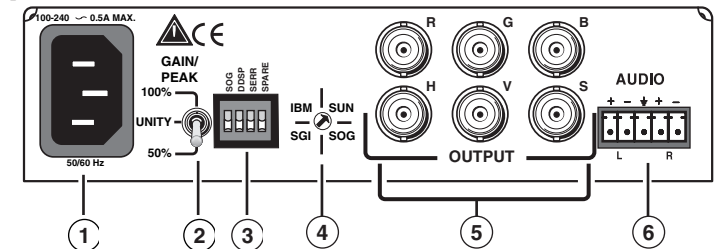

**Figure 2-2 — Rear panel features (RGB 112xi shown)**

- 1 **IEC AC power connector** — Use this standard AC power connector with the supplied IEC power cable.
- 2 **Gain/peak switch** — Compensates for cable capacitance if the signal cable between the interface and the display device is longer than approximately 125 feet (38m). Turn the switch to the position that provides the best image on the output display device.

**100%** — Increases the output signal level and adds 100% of the maximum peaking to the signal.

**Unity** — The output level is the same as that of the input, with no added peaking.

**50%** — Increases the output signal level and adds 50% of the maximum peaking to the signal.

**NOTE** *If the signal cable between the interface and the display device is shorter than approximately 125 feet (38m), and the Gain/Peak switch is set to a setting other than Unity, the image may be overcompensated. If the edges of the image seem to exceed their boundaries, or if thin lines and sharp edges look thick and fuzzy, try changing the Gain/Peak settings.*

- ③ **DIP Switch** — Controls sync on green output, Digital Display Sync Processing, and serration pulse removal.

### 1 — SOG (sync on green output)

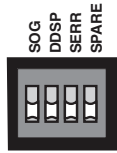

On — If this switch is set to On (up), the interface outputs sync on green.

Off — If this switch is set to Off (down), output is RGBS or RGBHV, depending on how the interface and projector are cabled.

### 2 — DDSP (Digital Display Sync Processing)

On — If this switch is set to On (up), the interface does not perform sync processing. This may be necessary for digital display devices, such as LCD, DLP, and plasma displays.

Off — If this switch is set to Off (down), the interface performs sync processing operations, such as horizontal shift, using Extron's ADSP.

**NOTE** *Turning on the DDSP feature disables the horizontal shift control.*

### 3 — SERR (serration pulses)

Many display devices, such as LCD and DLP projectors and plasma displays, must have serration pulses removed from the sync signal in order to display images properly. Flagging or bending at the top of the video image is a sign that the serration pulses should be removed.

On — If this switch is set to On, serration pulses are present on the output signal.

Off — If this switch is set to Off, serration pulses are not present on the output signal.

4 — SPARE — No function is assigned.

- ④ **CPU dial switch (RGB 112xi only)** — Use a Tweezer or a small screwdriver to set this switch to the type of computer attached to the RGB 112xi interface (IBM, Sun, or SGI), or if the computer produces sync on green only, set the switch to SOG.



- ⑤ **RGB output** — Connect coaxial cables to these female BNC connectors to an RGB output device. Connect cables for the appropriate signal type, as shown below.



- ⑥ **Audio output connector** — One 5-conductor, 3.5-mm captive screw terminal for audio output. See page 2-13 for audio connection details.

## Installation

### Overview

The installation procedure is the same for the RGB 109xi and the RGB 112xi, except that each interface attaches to a different type of computer. See "Cabling" on page 2-11 for more information.

To install and set up the RGB 109xi or the RGB 112xi for operation, perform the following basic steps (the remainder of this chapter provides detailed steps):

- 1 Turn off power to the computer or workstation and its monitor, and unplug the power cable from each of these devices. Turn off power to the projector, and unplug its power cord.
- 2 Disconnect the monitor signal cable from the computer. If speakers are attached to the computer's sound card, disconnect them as well.
- 3 If desired, change the configuration of jumper J20 (sync polarity) or J40 (vertical sync width). See "Setting internal jumpers" on page 2-6.
- 4 Set the DIP switches ID bit configuration (SOG, DDSP, SERR). See "Rear panel features" on page 2-3.
- 5 If desired, attach the interface to a table or under a podium using an optional Extron mounting kit. See "Mounting the interface" on page 2-9.
- 6 Attach the interface to the computer, attach the local monitor, if used, to the interface, and attach the projector to the interface. See "Cabling" on page 2-11.

**NOTE** *If you are not using a local monitor with the RGB 112xi, you must attach an MFTA (multi-frequency termination adapter) to simulate a monitor.*



- 7 Attach the interface to an audio system. See “Connecting audio” on page 2-12.
- 8 Plug the interface into a grounded AC power source.
- 9 Turn on the computer, monitor, and projector (or other display device).
- 10 The image from the computer should appear on the projector and monitor. If it does not, double check steps 3 through 6 and make adjustments as needed.

### Setting internal jumpers

The jumpers inside the interface are set at the factory for optimal use by most systems. However, you can change a jumper setting to meet the needs of a particular system.

**WARNING** Changes to internal jumper settings must be performed by authorized service personnel only.

The user-configurable, internal jumpers control the following functions:

**J20: Sync polarity jumper** — This jumper adjusts the output sync polarity. Horizontal (H) and vertical (V) sync output can either follow input sync polarity, or be forced to negative.

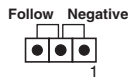

- If the jumper is on pins 1 and 2, output H and V sync polarities are forced to negative.
- If the jumper is on pins 2 and 3, output sync polarities follow input sync polarity: The output sync signals' polarity is the same as the input polarity. This is the default setting.

**J40: Vertical sync width jumper** — This jumper adjusts the vertical sync pulse width. Some digital display devices have very specific requirements for incoming sync pulse width. If no picture appears, the picture cuts in and out, or the picture is scrambled, try adjusting the vertical sync pulse width or switching from ADSP to DDSP.

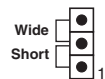

- If the jumper is on pins 1 and 2, the output vertical sync pulse will be short (narrow).
- If the jumper is on pins 2 and 3, the output vertical sync pulse will be wide. This is the default setting.

To change the jumper settings, do the following:

1. If the power cord is attached, remove power from the interface by disconnecting the AC power cord from the unit.
2. Remove the interface cover (the top half of the enclosure), as shown in figure 2-3. Remove the screws from the enclosure, slide the cover slightly towards the back of the enclosure, enough to clear the gain/peak switch, lift the cover, and place the cover upside down next to the base of the enclosure.

**CAUTION** Do not pull on the cable that attaches the cover to the base. Doing so could disconnect the cable from its connectors.

**CAUTION** Do not touch any switches or electronic components inside the interface. Doing so could damage the interface.

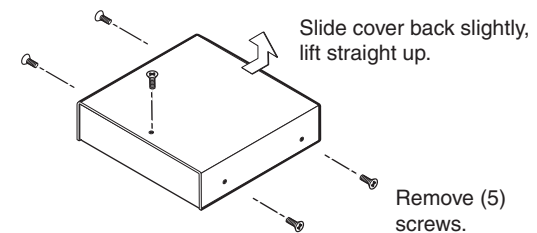

**Figure 2-3 — Opening the interface cover**

- Note the positions of jumpers J20 and J40 before changing jumper settings (figure 2-4). There are two possible setting combinations for 3-pin jumpers:

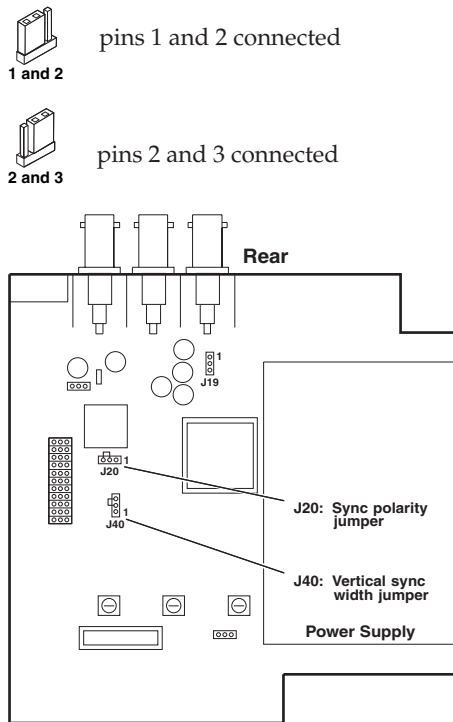

**Figure 2-4 — Circuit board jumper locations**

- To change the jumper configuration, use pliers to pull the jumper shunt off the pins, then place the jumper on the appropriate pins (figure 2-5).

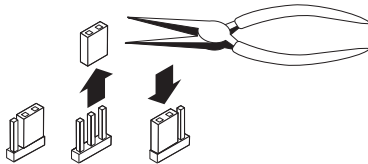

**Figure 2-5 — Changing jumper settings**

- Replace and fasten the enclosure cover, reversing step 2.

## Mounting the interface

### Under-desk Mounting

To mount the interface under a desk or in a podium using the under-desk mounting kit (Extron part number 70-077-01), do the following:

- Attach the mounting brackets to the interface using four machine screws supplied with the mounting kit (see figure 2-6).

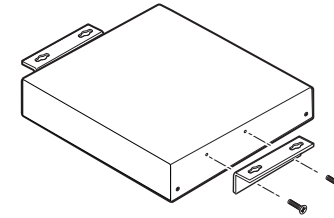

**Figure 2-6 — Attaching the under desk brackets**

- Using the template on page A-6 to guide you, mark the four screw holes on the underside of the surface to which you are mounting the interface.
- Drill four pilot holes, each 3/32" (2.4 mm) in diameter by 1/4" (6.4 mm) deep, where marked on the template.
- Using the four wood screws provided, attach the brackets under the mounting surface (see figure 2-7).

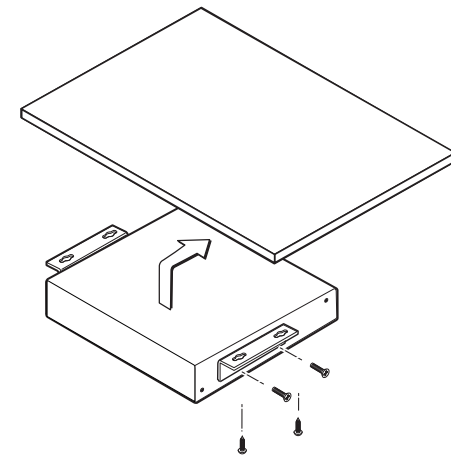
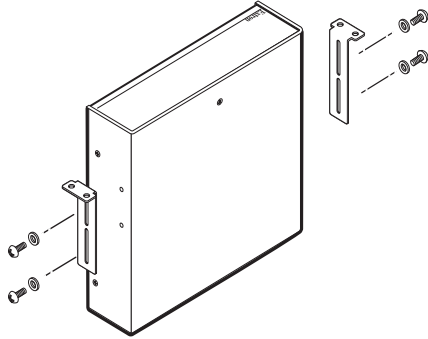

**Figure 2-7 — Under-desk mounting**

### Through-desk mounting

To mount the interface through a desk or table using the through-desk mounting kit (Extron part number 70-077-02), do the following:

1. Attach the mounting brackets to the interface using four machine screws and washers (supplied with the mounting kit), as indicated in figure 2-8.



**Figure 2-8 — Attaching the through desk brackets**

2. Using the through-desk template on page A-6 to guide you, mark the four screw holes on the underside of the surface to which you are mounting the interface.
3. Drill four pilot holes, each 3/32" (2.4 mm) in diameter by 1/4" (6.4 mm) deep, where marked on the template.
4. Using the four wood screws provided, attach the brackets to the mounting surface, as shown in figure 2-9.

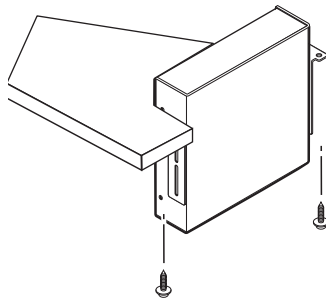

**Figure 2-9 — Through-desk mounting**

### Cabling

Each interface can connect to the computer or workstation's local monitor and to a projector or other display device.

Figures 2-10 and 2-11 show how to connect each of the interfaces.

1. Connect the local monitor's video signal cable to the interface connector labeled "Buffered Local Monitor Output".

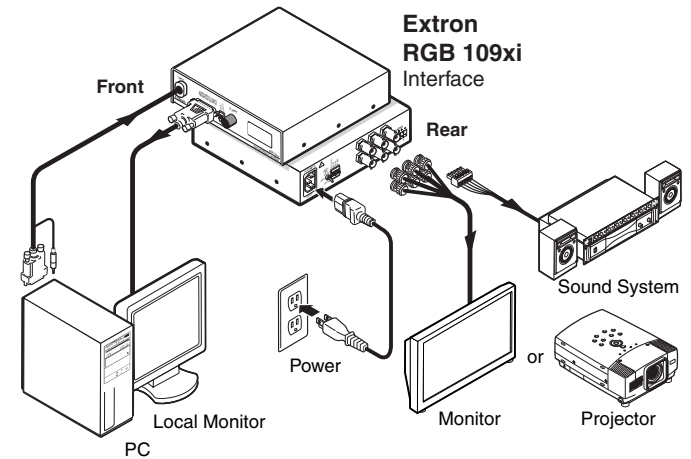

**Figure 2-10 — RGB 109xi installation**

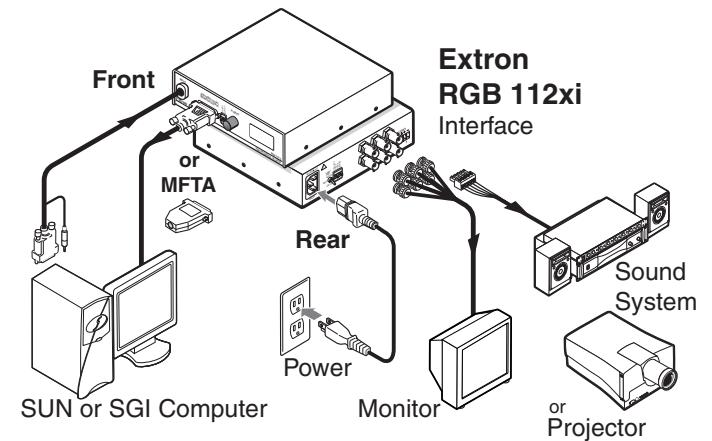

**Figure 2-11 — RGB 112xi installation**

## Controls and Installation, cont'd

2. Connect the interface cable marked "Video input" to the computer's video output (where the monitor was originally connected).
3. Connect the audio cable connector on the interface cable to the computer's audio line output (where the powered speakers were originally connected).
4. Use BNC cables to attach the interface to a projector or other display device.

**RGsB** – If coax cables are connected and terminated (75 ohms) to the red, green, and blue channels only, and the SOG switch is set to On (see page 2-4), the output is sync on green.



**RGBS** – If the S (composite sync) cable is connected, the output is composite sync.



**RGBHV** – If both the H & V cables are connected, the sync output is separate horizontal and vertical.



### Connecting audio

Before connecting audio, determine whether your audio system is unbalanced or balanced. Then, follow the instructions on page 2-12 or 2-13, to connect unbalanced or balanced audio.

**CAUTION** *Wiring the audio incorrectly may damage the audio output circuits.*

#### Unbalanced audio

To attach the interface to an unbalanced audio system, do the following:

1. Attach the audio cable to an unbalanced speaker input connector (tip and sleeve).

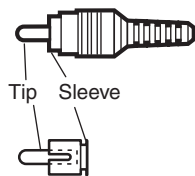

2. Attach the audio cable to the captive screw connector (Extron part number 10-319-10) as shown below. Fasten down the captive screws inside the audio cable connector.

#### Unbalanced Output

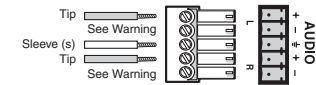

**CAUTION** *Connect the sleeve(s) to ground (GND). Connecting the sleeve(s) to a negative (-) terminal will damage audio output circuits.*

3. Slide the audio cable connector into the audio output connector on the interface.

#### Balanced audio

To attach the interface to a balanced audio system, do the following:

1. Attach the audio cable to a balanced speaker input connector (tip, ring, and sleeve).

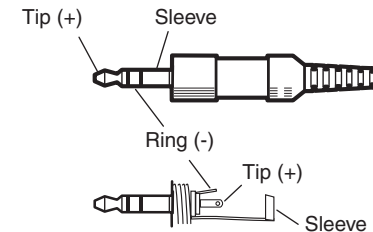

2. Attach the audio cable to the captive screw connector (Extron part number 10-319-10) as shown below. Fasten the captive screws inside the audio cable connector.

#### Balanced Output

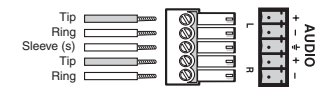

3. Slide the audio cable connector into the audio output connector on the interface.



# A

## **Appendix A**

### **Reference Information**

Specifications

Part Numbers

Mounting Templates

## Reference Information

### Specifications

Specifications apply equally to both units, except where noted.

#### Video input

Number/type .....	1 analog RGBHV, RGBS, RGsB, RsGsBs
Connectors .....	RGB 109xi: 1 15-pin HD male, 48" (122 cm) long cable RGB 112xi: 1 13W3 male, 48" (122 cm) long cable
Nominal level(s) .....	Analog — 0.3 V to 1.5 Vp-p
Maximum level(s) .....	Analog — 1.5 Vp-p
Impedance .....	75 ohms
Horizontal frequency.....	Autoscan 15 kHz to 130 kHz
Vertical frequency.....	Autoscan 30 Hz to 120 Hz
Return loss .....	-30 dB @ 5 MHz
Maximum DC offset .....	4.0 V

#### Video throughput

Gain .....	Unity, 0.725 Vp-p with 50% peaking, 0.750 Vp-p with 100% peaking
Bandwidth .....	300 MHz (-3 dB)

#### Video output

Number/type/format.....	1 analog RGBHV, RGBS, RGsB
Connectors .....	6 BNC female RGB 109xi: 1 15-pin HD female local monitor output (buffered) RGB 112xi: 1 13W3 female local monitor output (buffered)
Nominal level .....	Analog 0.70 Vp-p, 0.725 Vp-p, or 0.750 Vp-p
Impedance .....	75 ohms
Return loss .....	-30 dB @ 5 MHz

#### Sync

Input type .....	RGBHV TTL ( $\pm$ ), RGBS TTL ( $\pm$ ), RGsB 0.3V (-), RsGsBs 1.3V (-)
Output type.....	RGBHV ( $\pm$ ), RGBS( $\pm$ ), RGsB (-)
Input level .....	2.0 V to 5.5 Vp-p with $\pm$ 0.2 VDC offset (max.)
Output level .....	4.0 V to 5.0 Vp-p

Input impedance .....	10 kohms
Output impedance .....	75 ohms
Max. propagation delay .....	48 ns
Max. rise/fall time .....	3.5 ns
Polarity.....	RGBHV: when RGBHV is input, polarity follows input; otherwise negative RGBS, RGsB: negative

#### Audio input

Number/type .....	1 PC level stereo, unbalanced
Connectors .....	1 3.5 mm stereo plug, 24" (61 cm) cable from computer video connector, 2 channel; tip (L), ring (R), sleeve (ground)
Impedance .....	10 kohms, DC coupled
Minimum level .....	100 mV
Maximum level .....	+8.5 dBu,..... (unbalanced) @ stated %THD+N

#### Audio throughput

Gain .....	Unbalanced 0 dB, balanced +6 dB
Frequency response .....	$\pm$ 0.05 dB 20 Hz to 20 kHz
THD + Noise .....	0.03% @1 kHz, 0.3% @ 20 kHz at rated maximum output drive
S/N .....	>90 dB, output 14 dBu, balanced
Stereo channel separation .....	>95 dB @ 1 kHz to 20 kHz

#### Audio output

Number/type .....	1 stereo (2 channel), balanced/unbalanced
Connectors .....	3.5 mm stereo captive screw terminal, 5 conductor, for left and right output
Impedance .....	50 ohms, unbalanced, 100 ohms balanced
Gain error .....	$\pm$ 0.1 dB channel to channel
Drive (600 ohm) .....	> +14 dBu, balanced at stated %THD+N

#### General

Power .....	100 VAC to 240 VAC, 50/60 Hz, 15 Watts, internal, auto-switchable
Temperature/humidity.....	Storage -40° to +158°F (-40° to +70°C) / 10% to 90%, non-condensing Operating +32° to +104°F (0° to +40°C) / 10% to 90%, non-condensing
Rack mount.....	No

## Reference Information, cont'd

Furniture mount.....	Yes, with optional kits: #70-077-01 (under-desk) #70-077-02 (through-desk)
Enclosure type .....	Metal
Enclosure dimensions .....	1.75" H x 6.38" W x 6.00" D 4.45 cm H x 16.19 cm W x 15.24 cm D
Shipping weight .....	3 lbs (1.4 kg)
Vibration .....	ISTA 1A in carton (International Safe Transit Association)
Approvals.....	UL, CUL, CE, FCC Class A
MTBF.....	30,000 hours
Warranty .....	3 years parts and labor

**NOTE** Specifications are subject to change without notice.

### Part Numbers

RGB 109xi .....	60-289-01
RGB 112xi .....	60-282-01

### Included parts

Unless otherwise noted, these items are included in each order for an RGB 109xi and RGB 112xi:

Included items	Part number
Rubber feet	
IEC power cord	
Tweezer	
SUN-MFTA terminal adapter (RGB 112xi only)	26-343-01
3.5 mm, 5-pole captive screw connector	10-319-10
RGB 109xi and RGB 112xi User's Manual	

### Optional accessories

Accessory	Part number
MBU 129 Through-desk mounting bracket kit	70-077-02
MBU 125 Under-desk mounting bracket kit	70-077-01
3.5 mm stereo plug	10-306-01

## BNC cables

BNC Cable	Part #
<b>BNC-5 Mini HR Cables</b>	
BNC-5 3' (1 m) HR	26-260-15
BNC-5 6' (2 m) HR	26-260-01
BNC-5 12' (4 m) HR	26-260-02
BNC-5 25' (7.5 m) HR	26-260-03
BNC-5 35' (11 m) HR	26-260-17
BNC-5 50' (15 m) HR	26-260-04
BNC-5 75' (23 m) HR	26-260-16
BNC-5 100' (30 m) HR	26-260-05
<b>BNC-5 Mini HR Cables, Plenum</b>	
BNC-5 3' HRP	26-378-01
BNC-5 6' HRP	26-378-02
BNC-5 12' HRP	26-378-03
BNC-5 25' HRP	26-378-04
BNC-5 35' HRP	26-378-12
BNC-5 50' HRP	26-378-05
BNC-5 75' HRP	26-378-06
BNC-5 100' HRP	26-378-07

## Reference Information, cont'd

### Mounting templates

**NOTE** All dimensions are in inches. Drawings not to scale.

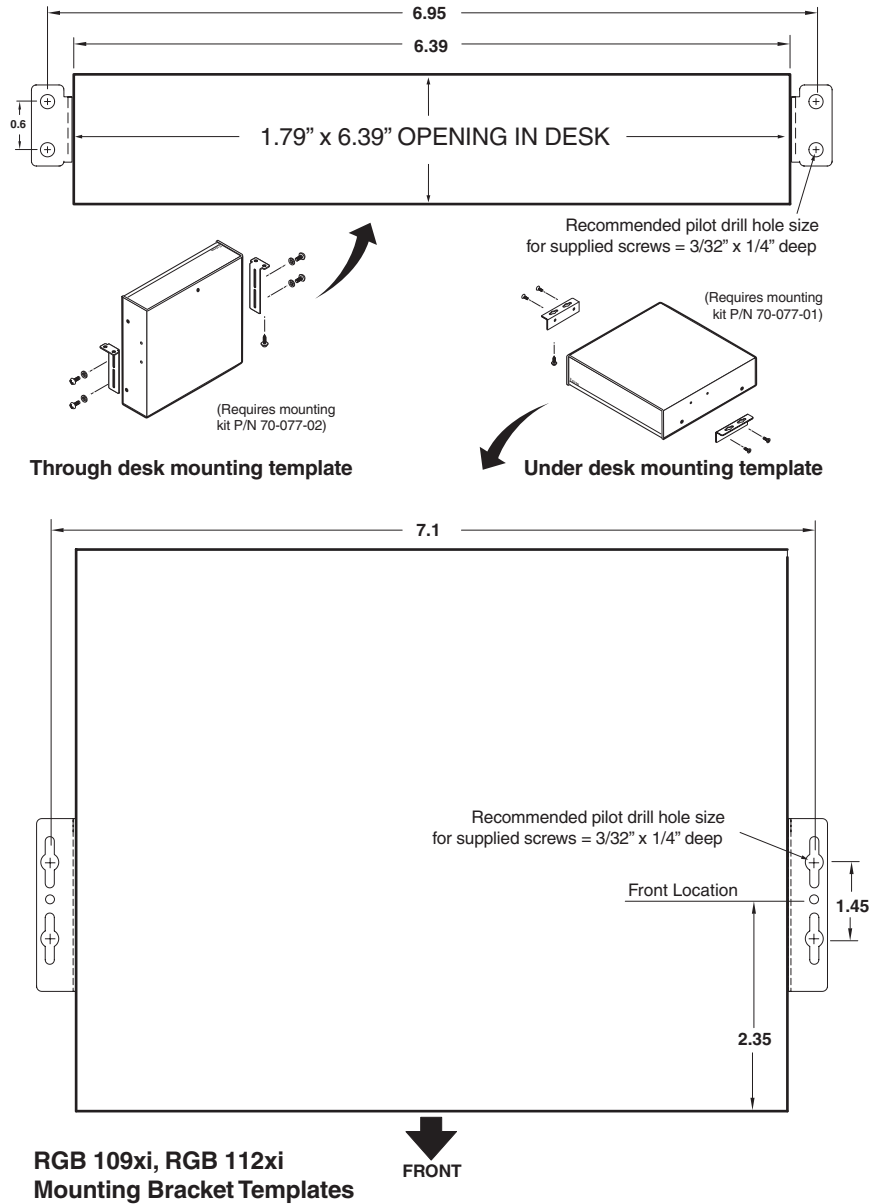

RGB 109xi, RGB 112xi  
Mounting Bracket Templates

## FCC Class A Notice

Note: This equipment has been tested and found to comply with the limits for a Class A digital device, pursuant to part 15 of the FCC Rules. These limits are designed to provide reasonable protection against harmful interference when the equipment is operated in a commercial environment. This equipment generates, uses and can radiate radio frequency energy and, if not installed and used in accordance with the instruction manual, may cause harmful interference to radio communications. Operation of this equipment in a residential area is likely to cause harmful interference, in which case the user will be required to correct the interference at his own expense.

Note: This unit was tested with shielded cables on the peripheral devices. Shielded cables must be used with the unit to ensure compliance.

## Extron's Warranty

Extron Electronics warrants this product against defects in materials and workmanship for a period of three years from the date of purchase. In the event of malfunction during the warranty period attributable directly to faulty workmanship and/or materials, Extron Electronics will, at its option, repair or replace said products or components, to whatever extent it shall deem necessary to restore said product to proper operating condition, provided that it is returned within the warranty period, with proof of purchase and description of malfunction to:

**USA, Canada, South America, and Central America:**  
Extron Electronics  
1001 East Ball Road  
Anaheim, CA 92805, USA

**Europe, Africa, and the Middle East:**  
Extron Electronics, Europe  
Beeldschermweg 6C  
3821 AH Amersfoort  
The Netherlands

**Asia:**  
Extron Electronics, Asia  
135 Joo Seng Road, #04-01  
PM Industrial Bldg.  
Singapore 368363

**Japan:**  
Extron Electronics, Japan  
Kyodo Building  
16 Ichibancho  
Chiyoda-ku, Tokyo 102-0082  
Japan

This Limited Warranty does not apply if the fault has been caused by misuse, improper handling care, electrical or mechanical abuse, abnormal operating conditions or non-Extron authorized modification to the product.

*If it has been determined that the product is defective, please call Extron and ask for an Applications Engineer at (714) 491-1500 (USA), 31.33.453.4040 (Europe), 65.6383.4400 (Asia), or 81.3.3511.7655 (Japan) to receive an RA# (Return Authorization number). This will begin the repair process as quickly as possible.*

Units must be returned insured, with shipping charges prepaid. If not insured, you assume the risk of loss or damage during shipment. Returned units must include the serial number and a description of the problem, as well as the name of the person to contact in case there are any questions.

Extron Electronics makes no further warranties either expressed or implied with respect to the product and its quality, performance, merchantability, or fitness for any particular use. In no event will Extron Electronics be liable for direct, indirect, or consequential damages resulting from any defect in this product even if Extron Electronics has been advised of such damage.

Please note that laws vary from state to state and country to country, and that some provisions of this warranty may not apply to you.





**Extron Electronics, USA**  
1230 South Lewis Street  
Anaheim, CA 92805  
800.633.9876 714.491.1500  
FAX 714.491.1517

**Extron Electronics, Europe**  
Beeldschermweg 6C  
3821 AH Amersfoort, The Netherlands  
+800.3987.6673 +31.33.453.4040  
FAX +31.33.453.4050

**Extron Electronics, Asia**  
135 Joo Seng Rd. #04-01  
PM Industrial Bldg., Singapore 368363  
+800.7339.8766 +65.6383.4400  
FAX +65.6383.4664

**Extron Electronics, Japan**  
Kyodo Building, 16 Ichibancho  
Chiyoda-ku, Tokyo 102-0082  
Japan  
+81.3.3511.7655 FAX +81.3.3511.